

Specification-grade wet-location luminaire for wall mount applications.

- Machined 6061-T6 copper-free aluminum. Aluminum components are black anodized, then a polyester powder coat finish is applied.
- Seven standard TGIC powder coat finishes and clear anodized finish available.
- Remote transformer required.
- Stainless steel hardware.
- 10" 18ga. Teflon coated wire leads.
- 45° angled lens cap holds 3 lens accessories.
- Three mounting plate options.
- Clear tempered glass lens, glued in.
- High-temperature silicone O-ring seal used to seal the cap against the body.
- Molded silicone wire pass-thru attached to socket wire prevents wicking and water leaking into the lamp compartment.
- Listed for wet location use.
- Warranty: 10 Years.

Mounting Plate Options:

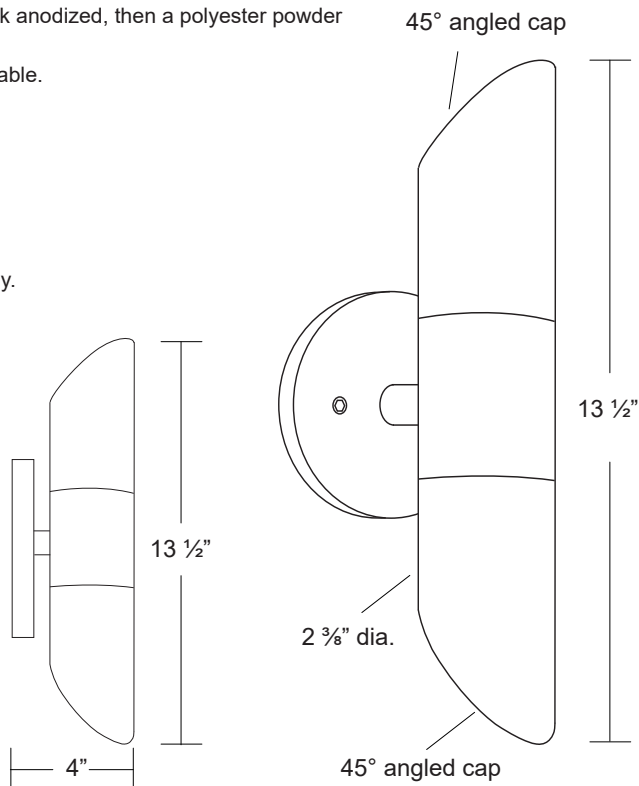
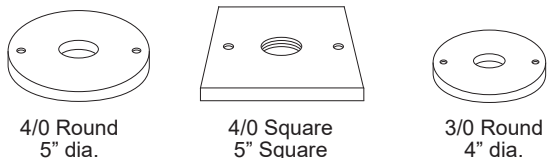

Specifications

MODEL:	WA-10	LAMPING:	MR16 Halogen, 35W Maximum (X2)(order separately) 8W LED (X2)(order separately)
MATERIAL:	6061-T6 Aluminum		
VOLTAGE:	12V		
WATTAGE:	35 Watt (X2) 8W LED (X2)		
SOCKET:	GY-6.35 Bi-pin porcelain socket rated 600V, 250°C 18 ga, Teflon® coated leads.		

Ordering Logic:

MODEL	METAL	MOUNTING PLATE		FINISH	
WA - 10	A - Aluminum	1 - 4/0 Round 3 - 3/0 Round	2 - 4/0 Square	BK- Black BZ - Bronze WT - White BG - Beige	BKT - Black Texture BZT- Bronze Texture SL - Silver AC - Aged Copper

ORDERING EXAMPLE: WA - 10 - A - 1 - BK

Excelsior Lighting, Inc.

PROJECT

TYPE