

Specification-grade landscape lighting, wet-location luminaire for step lighting or path lighting applications.

- Machined aluminum, available in seven standard TGIC powder coat finishes and clear anodized finish.
- Machined brass available in two finishes.
- Remote transformer required.
- Stainless steel hardware.
- GY 6.35 bi pi socket
- Tempered crystalline spread lens.
- 6 feet of 16/2 low voltage cable supplied.
- Mounting hardware not supplied.
- Core drill design for masonry (2 1/2" hole required).
- High-temperature silicone O-ring seal used to seal the cap against the body.
- Molded silicone wire pass-thru attached to socket wire prevents wicking and water leaking into the lamp compartment.
- Listed for wet location use.
- Warranty: Aluminum: 10 Years, Brass: 25 Years.

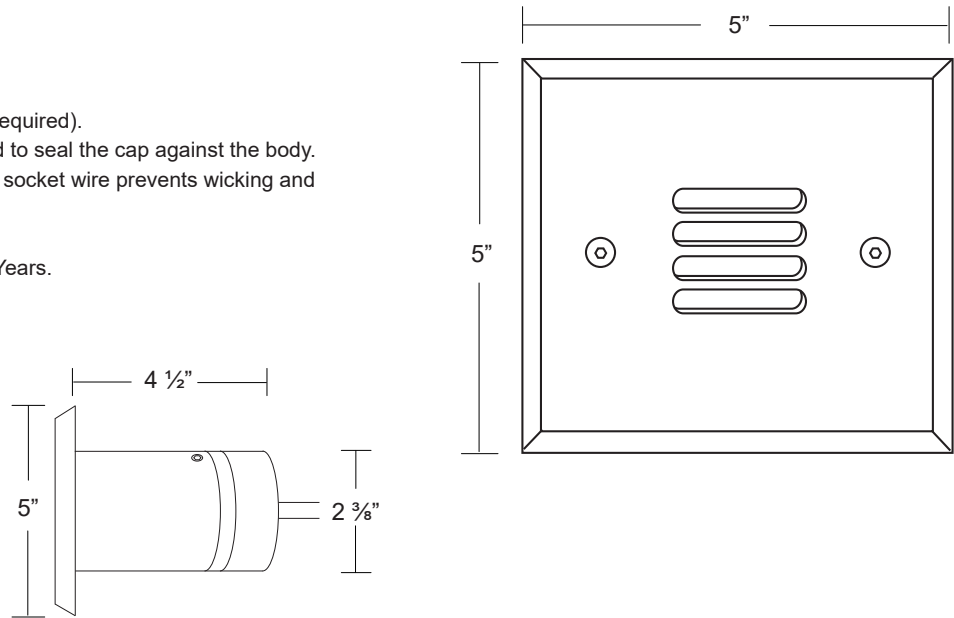

Specifications

MODEL:	ST-3	LAMPING:	MR16 Halogen, 20W Maximum (order separately) 8W LED (order separately)
MATERIAL:	Aluminum or Brass		
VOLTAGE:	12V		
WATTAGE:	20 Watt		
SOCKET:	GY 6.35 Bi-pin porcelain socket rated 600V, 250°C 18 ga, Teflon® coated leads.		

Ordering Logic:

MODEL	METAL	FINISH	
ST - 3	A - Aluminum B - Brass	BK - Black BZ - Bronze WT - White BG - Beige NT - Natural	BKT - Black Texture BZT - Bronze Texture SL - Silver AC - Aged Copper DB - Dark Brass

ORDERING EXAMPLE: ST - 3 - A - BK

Excelsior Lighting, Inc.

PROJECT

TYPE