

4/0 junction box cover with locking feature. Utilized for junction mount installations.

- Machined aluminum construction.
- Seven standard TGIC powder coat finishes and clear anodized finish available.
- 1/2" NPS mount threads, accepts industry standard luminaires.
- 10-32 set screw provides positive locking.
- Warranty: 10 Years.

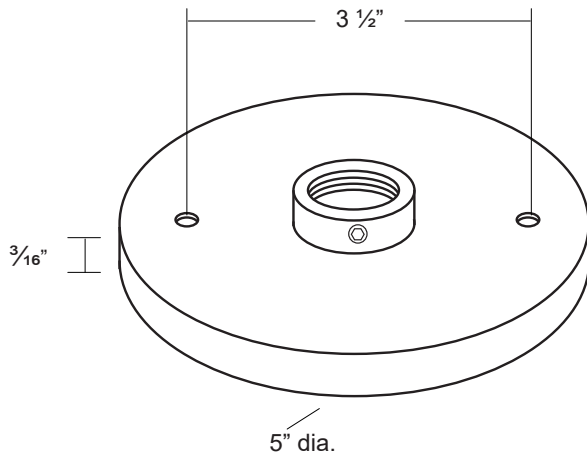

Specifications

MODEL: MT-42
 MATERIAL: Machined Aluminum
 MOUNTING: 1/2" NPS

Ordering Logic:

MODEL	METAL	FINISH	
MT - 42	A - Aluminum	BK- Black BZ - Bronze WT - White BG - Beige	BKT - Black Texture BZT- Bronze Texture SL - Silver AC - Aged Copper

ORDERING EXAMPLE: MT - 42 - A - BK

Excelsior Lighting, Inc.

PROJECT

TYPE